

• MALL • KONSTRUKTOR •

• CONSTRUCTOR •









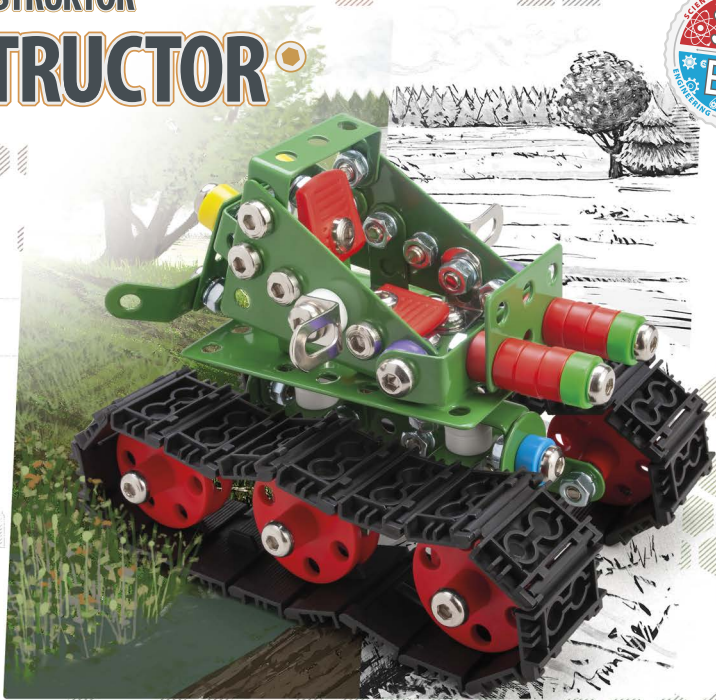

8+

219

TANKY

2809



-  x 2
-  x 2
-  x 4
-  x 2
-  x 4
-  x 2
-  x 6

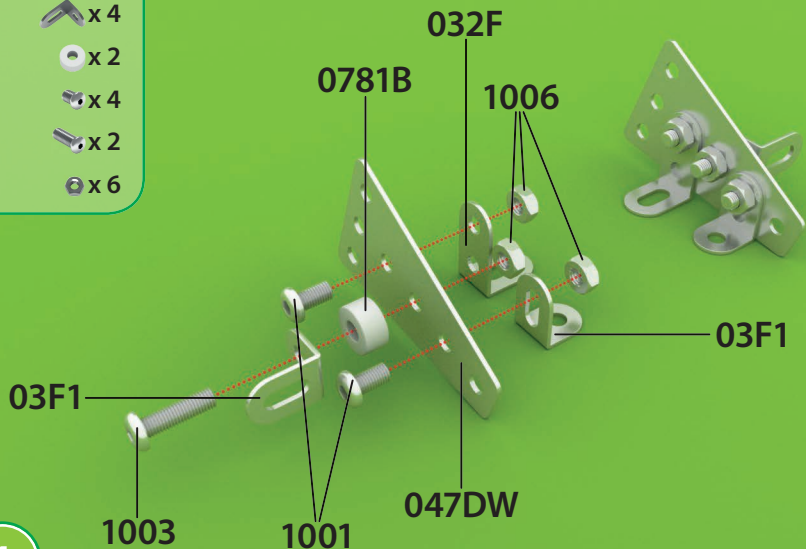

1

-  x 1
-  x 2
-  x 2

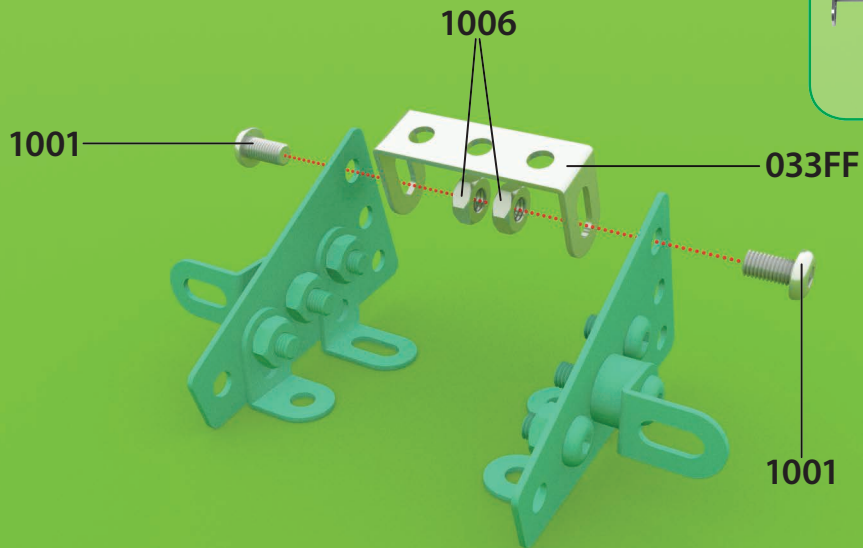



x 1



x 4



x 4

0425

1006

1001

3

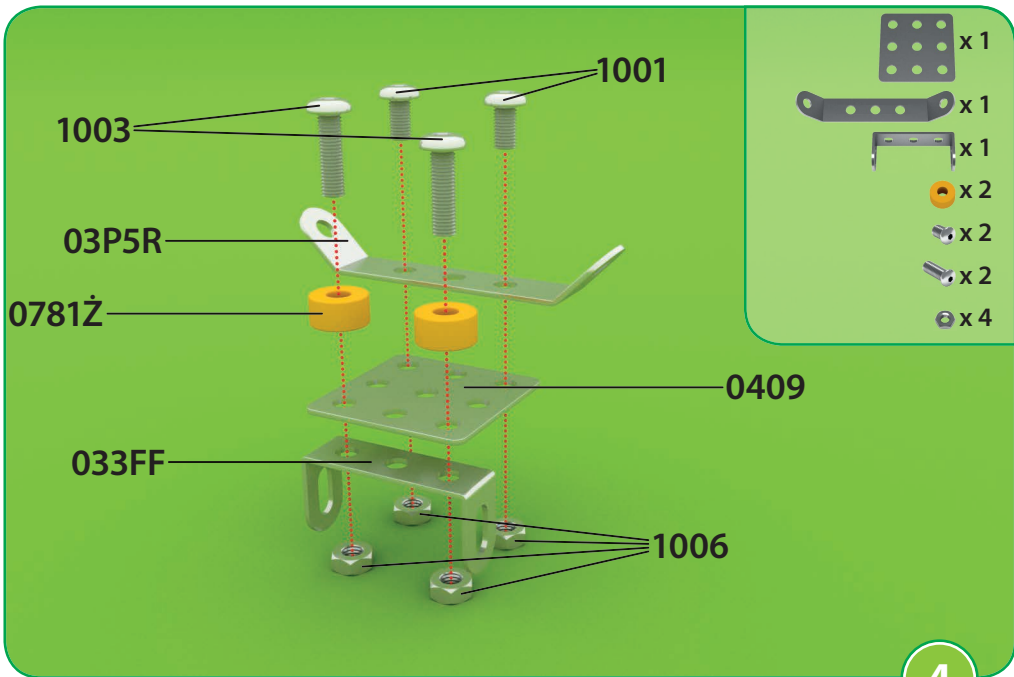

 x 2

 x 2

1001

1006

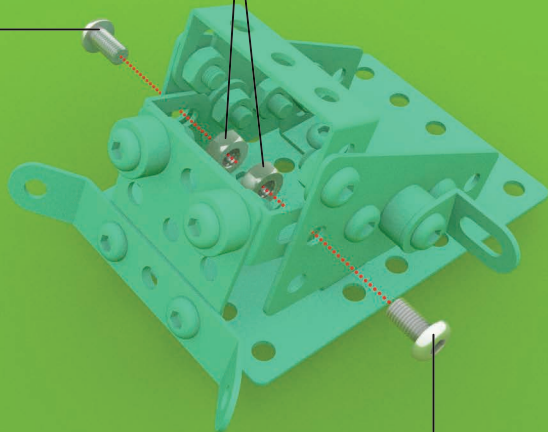

1001

5

x 2

x 2

x 2

1003

0782

1006

0782

1003

7

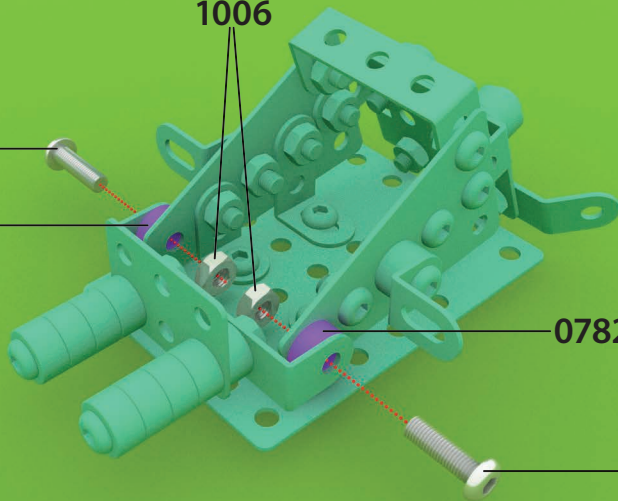

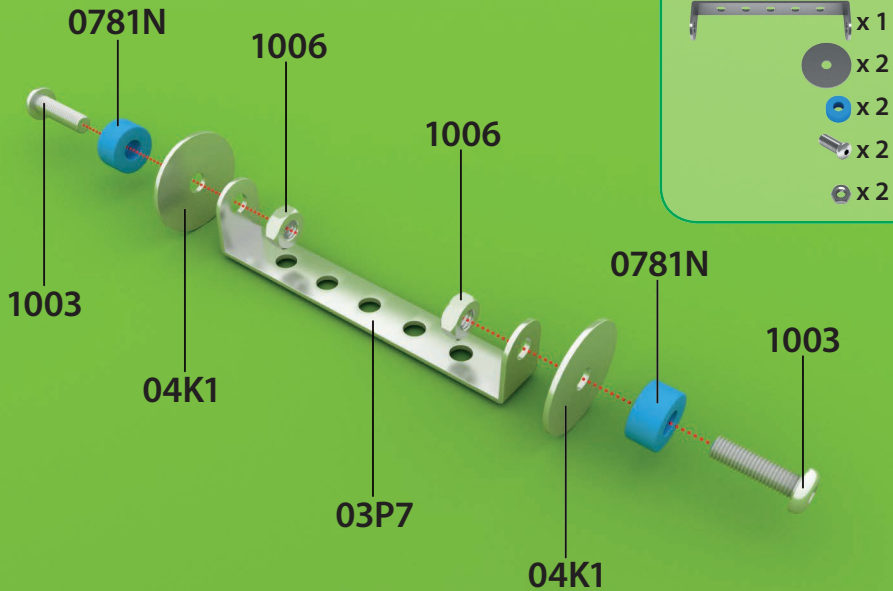



x 2



x 2





x 4

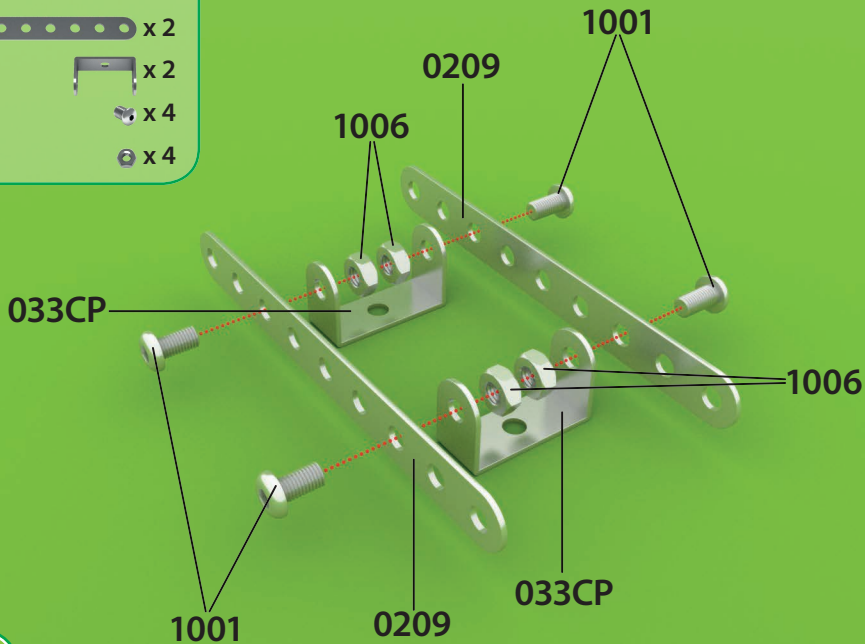

x 4

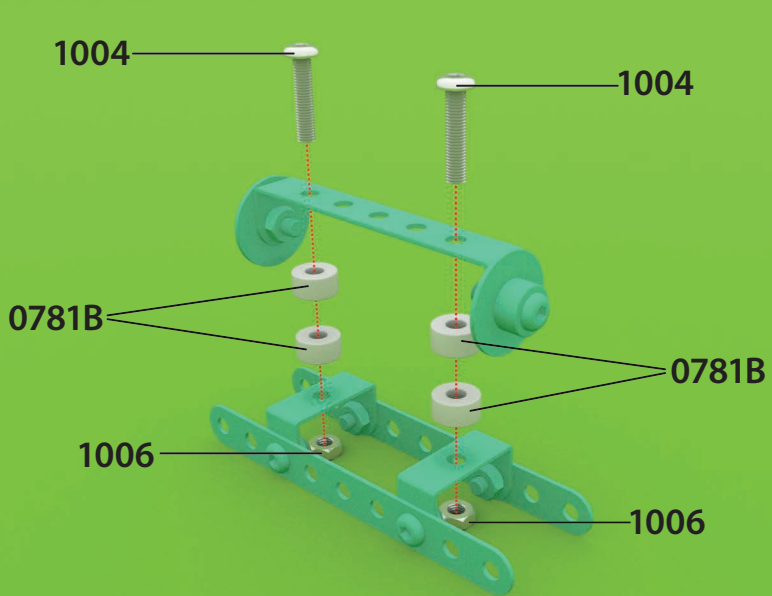



-  x 4
-  x 2
-  x 2



x 12



x 6



x 6



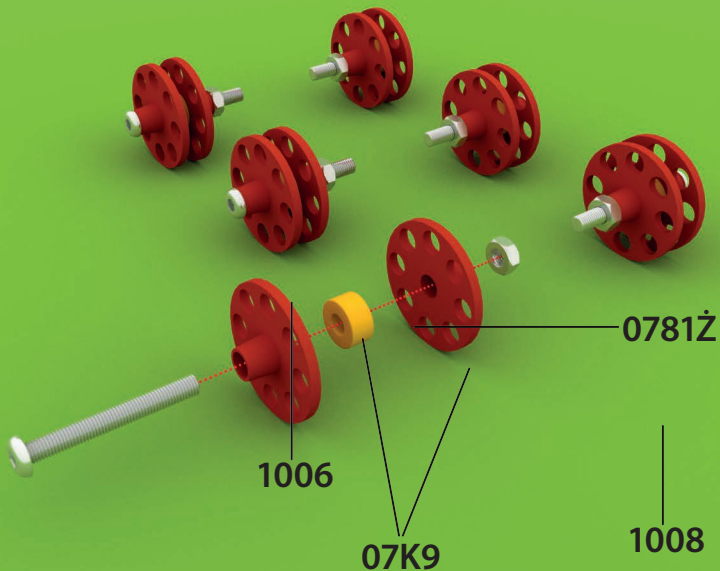

x 6

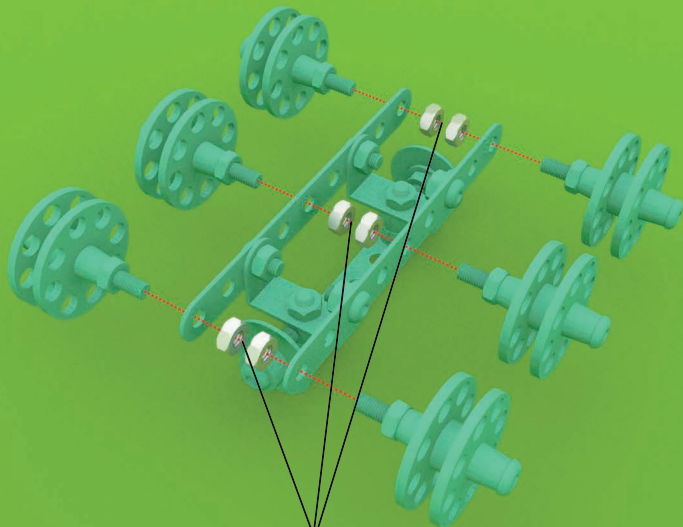

 x 6



1006 x 2

-  x 2
-  x 1
-  x 2

1005

0781B

1006

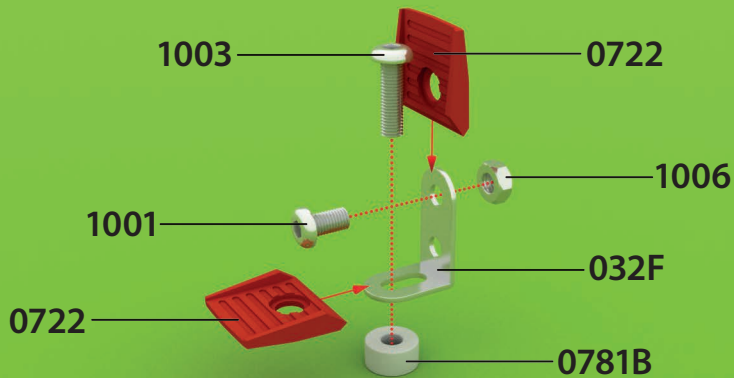

x 1

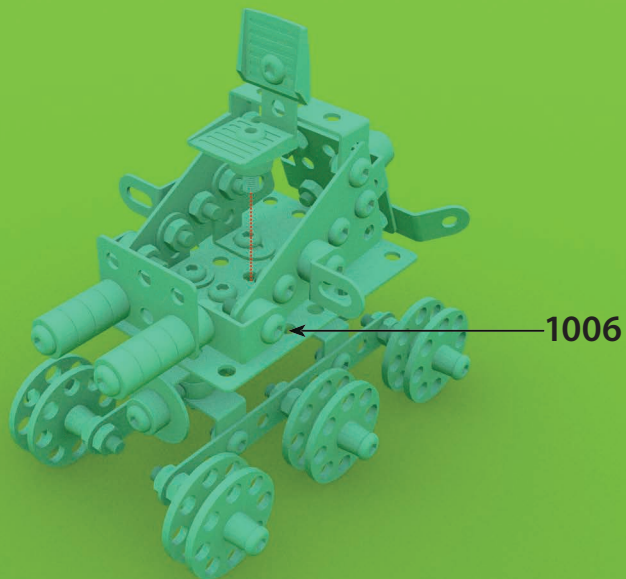

 x 36

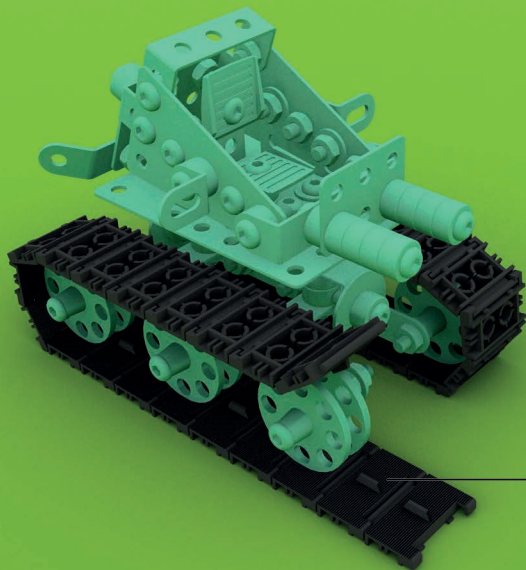

ALX 11020

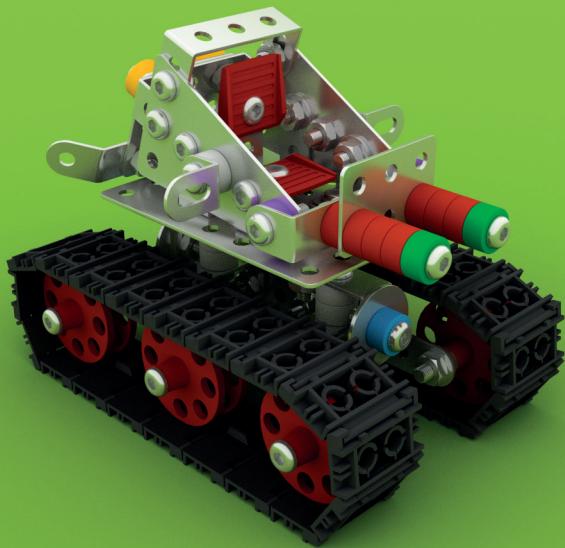

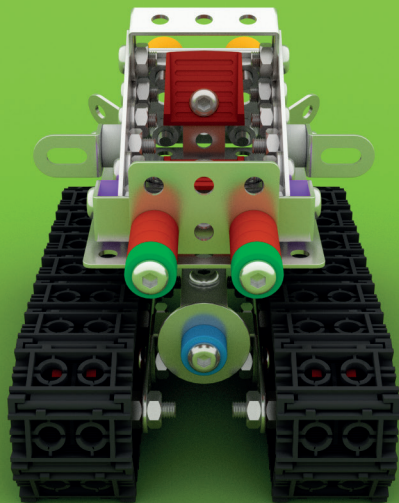

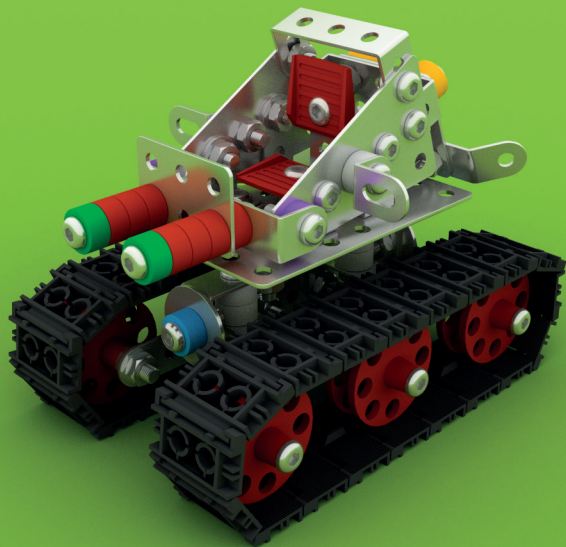



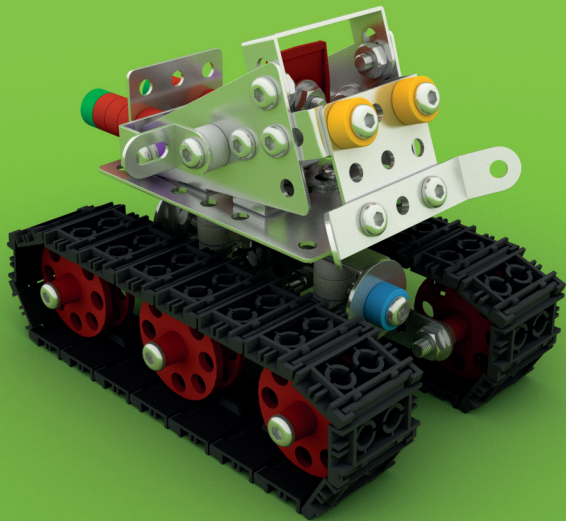

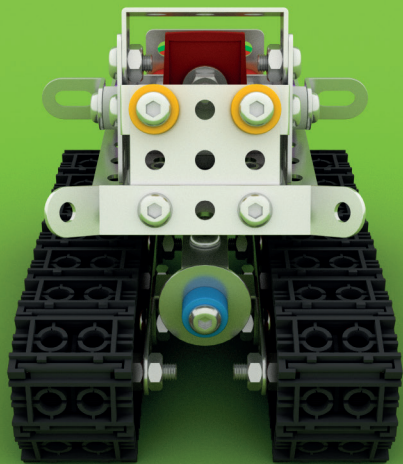

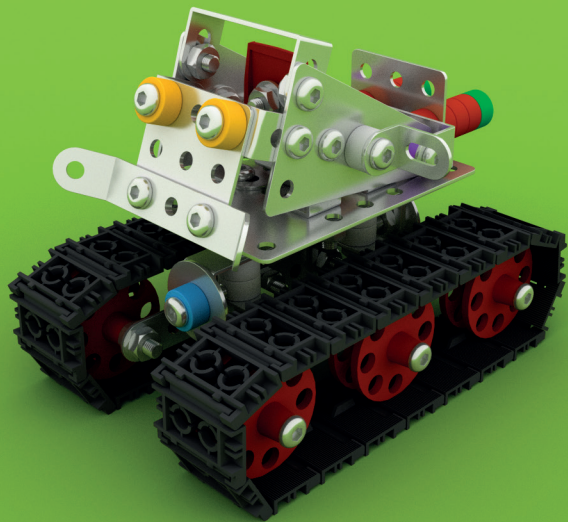

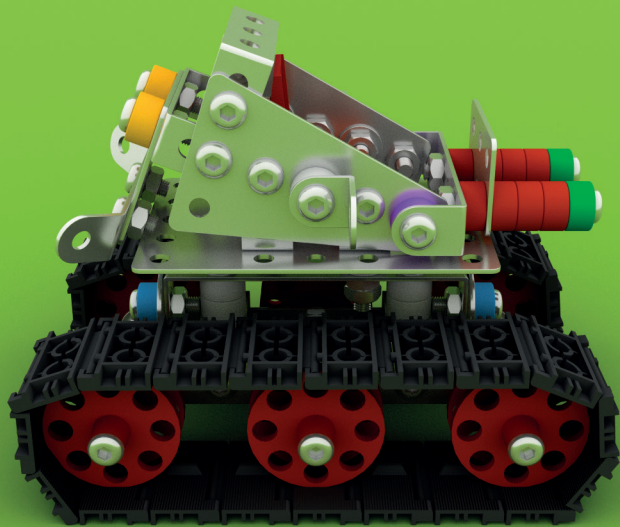

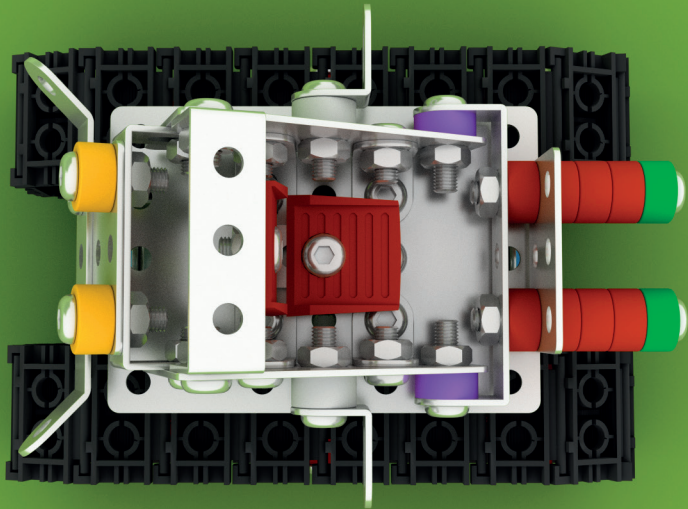



0101 x 1

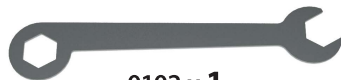

0102 x 1

M4 - 6mm



1001 x 19

M4 - 12mm



1003 x 9

M4 - 16mm



1004 x 2

M4 - 20mm



1005 x 1

M4 - 30mm



1008 x 8



1006 x 46



1007 x 30



0209 x 2



03F1 x 4



032F x 3



03P5R x 1



033CP x 2



033FF x 2



03P5 x 1



03P7 x 1



0406 x 1

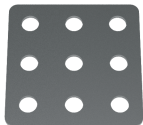

0409 x 1

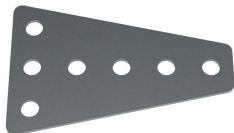

047DW x 2

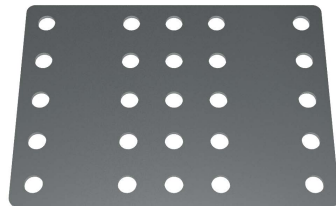

0425 x 1



04K1 x 2



0722 x 2



07K9 x 12



ALX 11020 x 36



0781Z x 8



0781Z x 2



0781CZ x 8



0781B x 9



0781N x 2



0782F x 2

PL: Ostrzeżenia! Nieodpowiednie dla dzieci w wieku poniżej 3 lat. Zestaw zawiera małe elementy – niebezpieczeństwo zakrztuszenia. Prosimy zachować opakowanie ze względu na podane informacje. **EN:** Warnings! Unsuitable for children under the age of 3. Contains small parts – choking hazard. Keep the box for future reference. **DE:** Achtung! Nicht für Kinder unter 3 Jahren geeignet. Enthält kleine Teile, die verschluckt werden können – Erstickungsgefahr. Verpackung für spätere Rückfragen aufbewahren. **FR:** Attention! Ne convient pas aux enfants de moins de 3 ans. Contient des petits éléments pouvant être avalés et engendrer un risque d'étouffement. Documentation à lire et à conserver pour consultation ultérieure. **ES:** ¡Advertencia! No recomendable para niños de 3 años o menores. Peligro de asfixia – piezas pequeñas. Conserve la caja para futuras referencias. **NL:** Waarschuwing! Niet geschikt voor kinderen jonger dan drie jaar. Bevat kleine onderdelen – verstikkingsgevaar opleveren. Bewaar de verpakking, er staat belangrijke informatie op. **CZ:** Upozornění! Nevhodné pro děti do 3 let. Balení obsahuje malé dílky – nebezpečí udušení. Zachovejte prosím obal ze vzhledu na uvedené informace. **SK:** Upozornenia! Nevhodné pre deti vo veku do 3 rokov. Súprava obsahuje malé časti – hrozí nebezpečenstvo udusenía. Obal uschovajte vzhľadom na dôležité informácie, ktoré sa na nom nachádzajú.

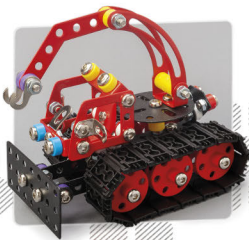
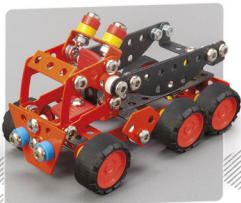
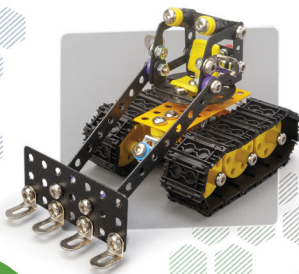

2809



www.alexander.com.pl