

•MAŁY•KONSTRUKTOR•
•CONSTRUCTOR•
JUNIOR



4+

68



Nº2586



SPOSÓB UŻYCIA NARZĘDZI

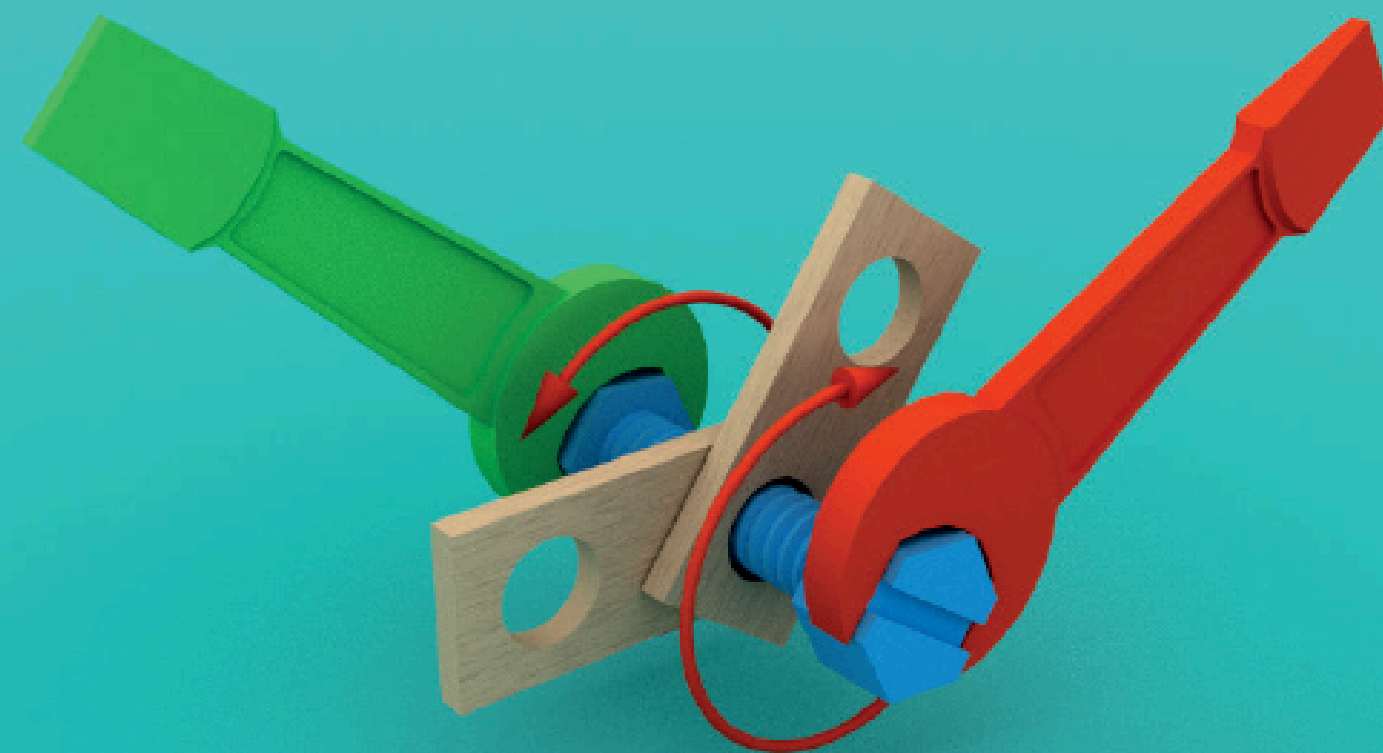
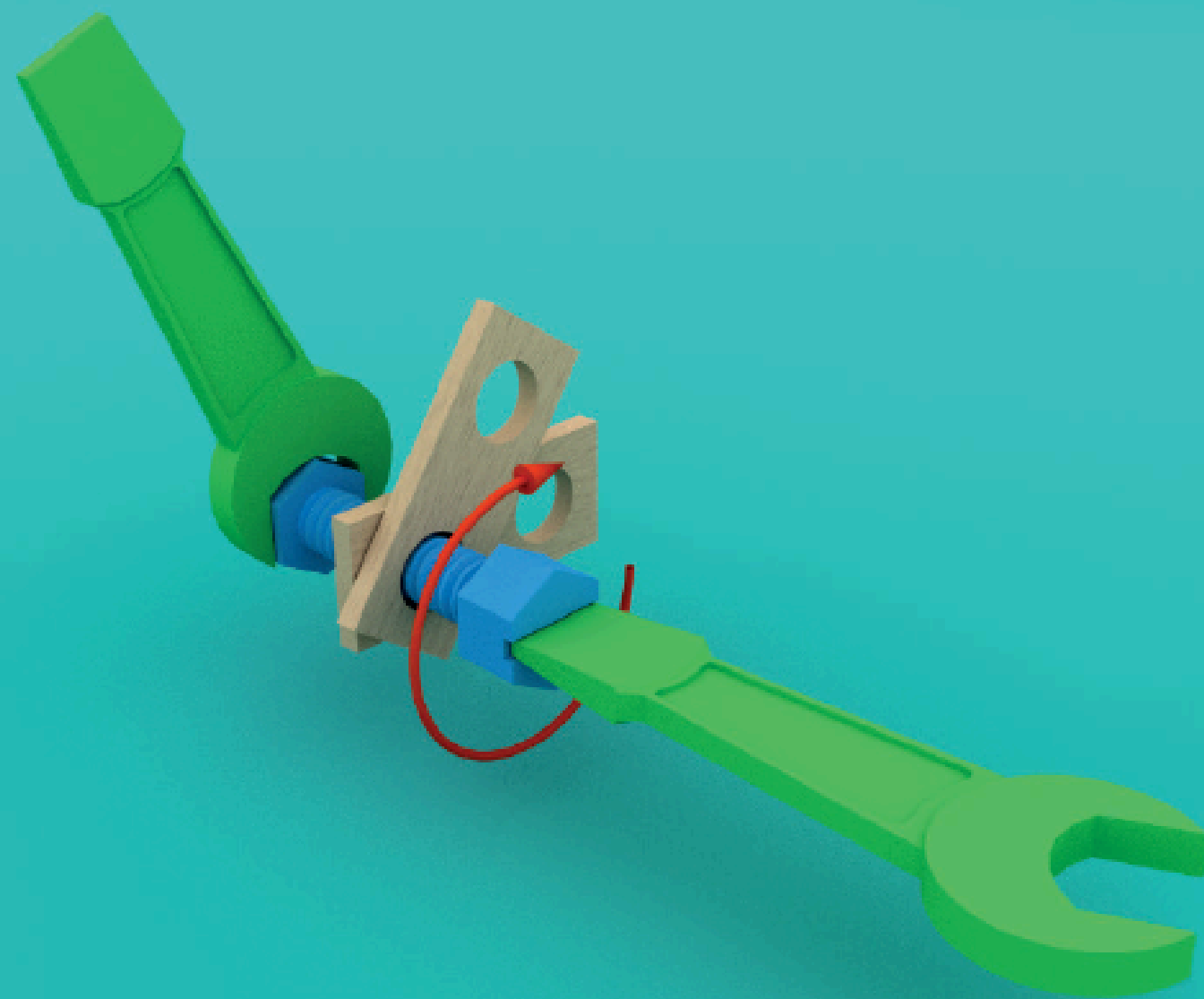



klucz x 2



D03 x 8



D04 x 4



D05 x 2



D07 x 1



D02 x 2



NP001 x 8



NP001 x 5



NP001 x 3



NP001 x 13

13mm



SP001 x 1

13mm



SP001 x 4

24mm



SP004 x 8



KP001 x 1



KP001 x 1

33mm

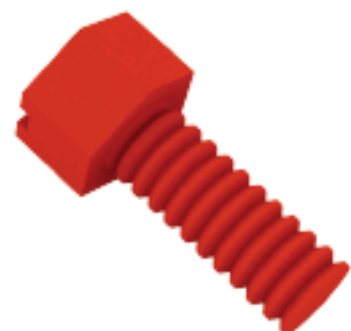

SP002 x 1

33mm



SP002 x 1

33mm



SP002 x 2

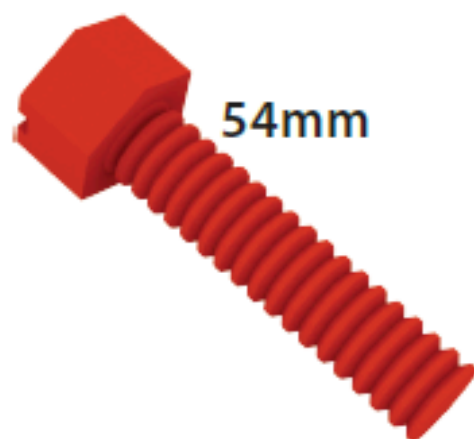

SP003 x 1

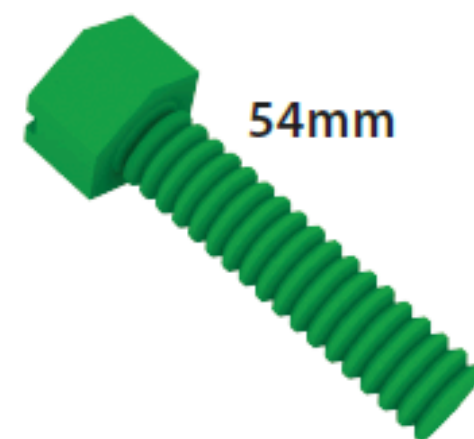

SP003 x 1



SP003 x 1

 x 1

 x 2

 x 2

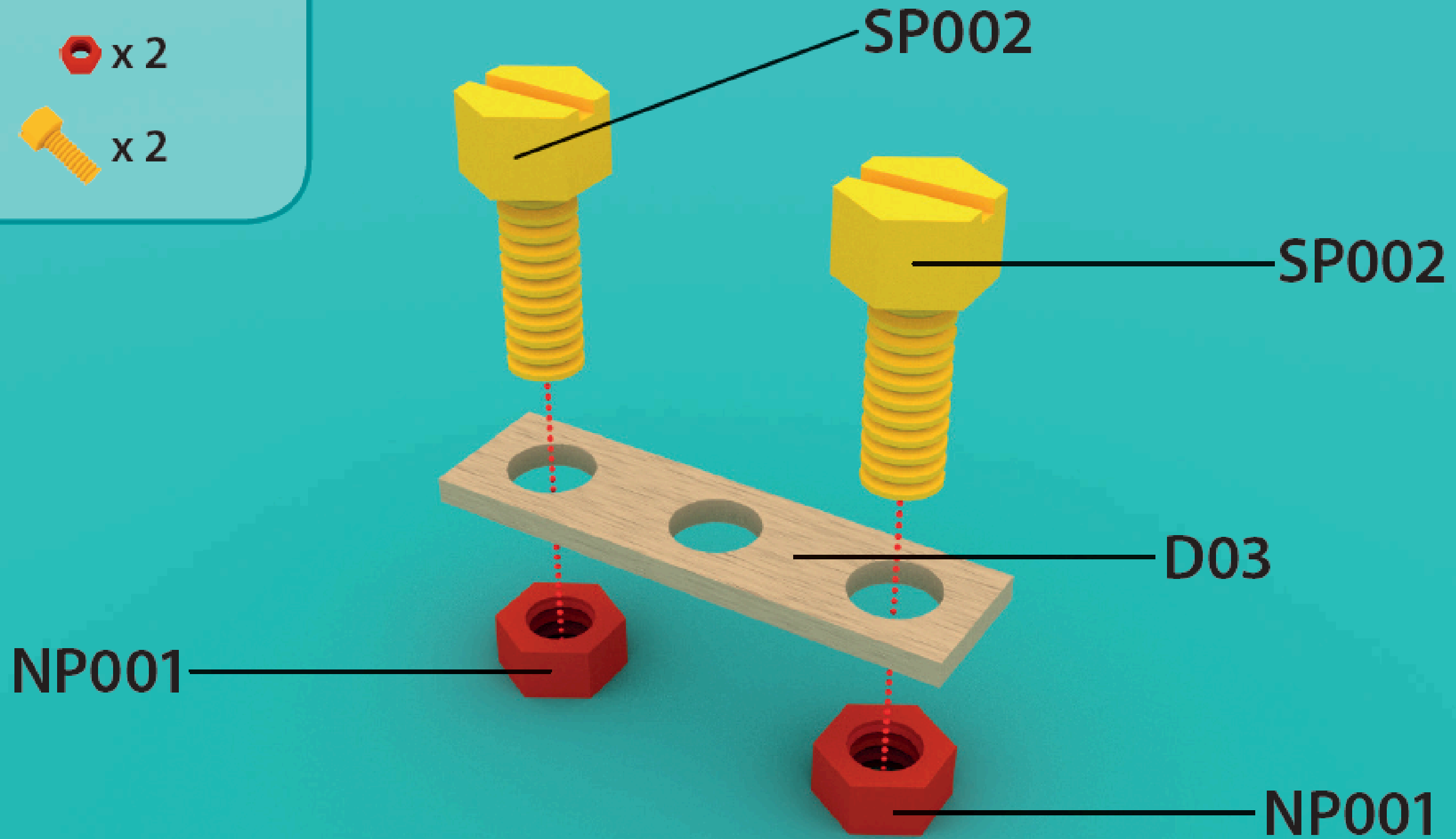



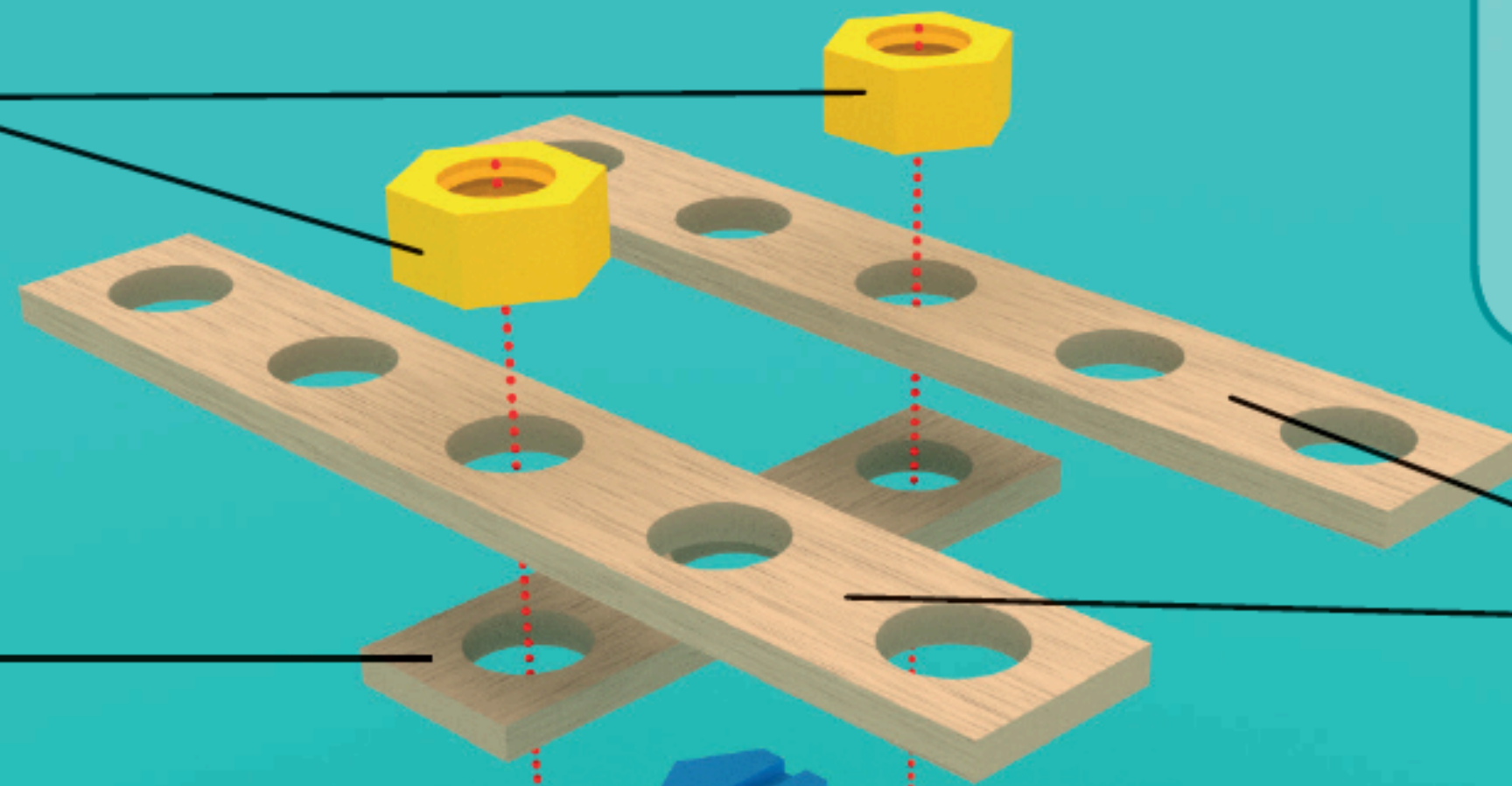

NP001



D03

D05

SP002

-  x 1
-  x 2
-  x 2
-  x 1

 x 4

 x 4

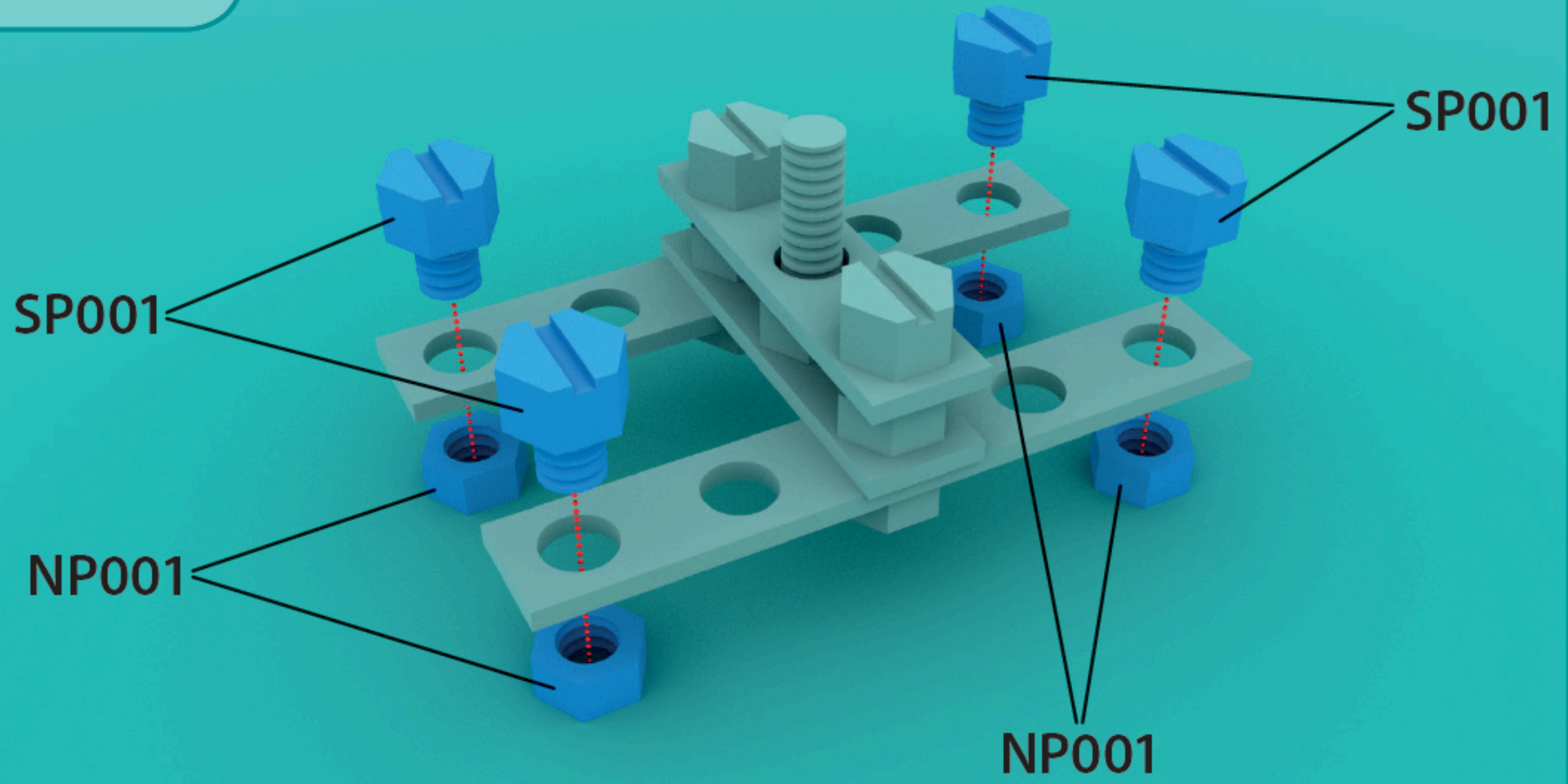

NP001

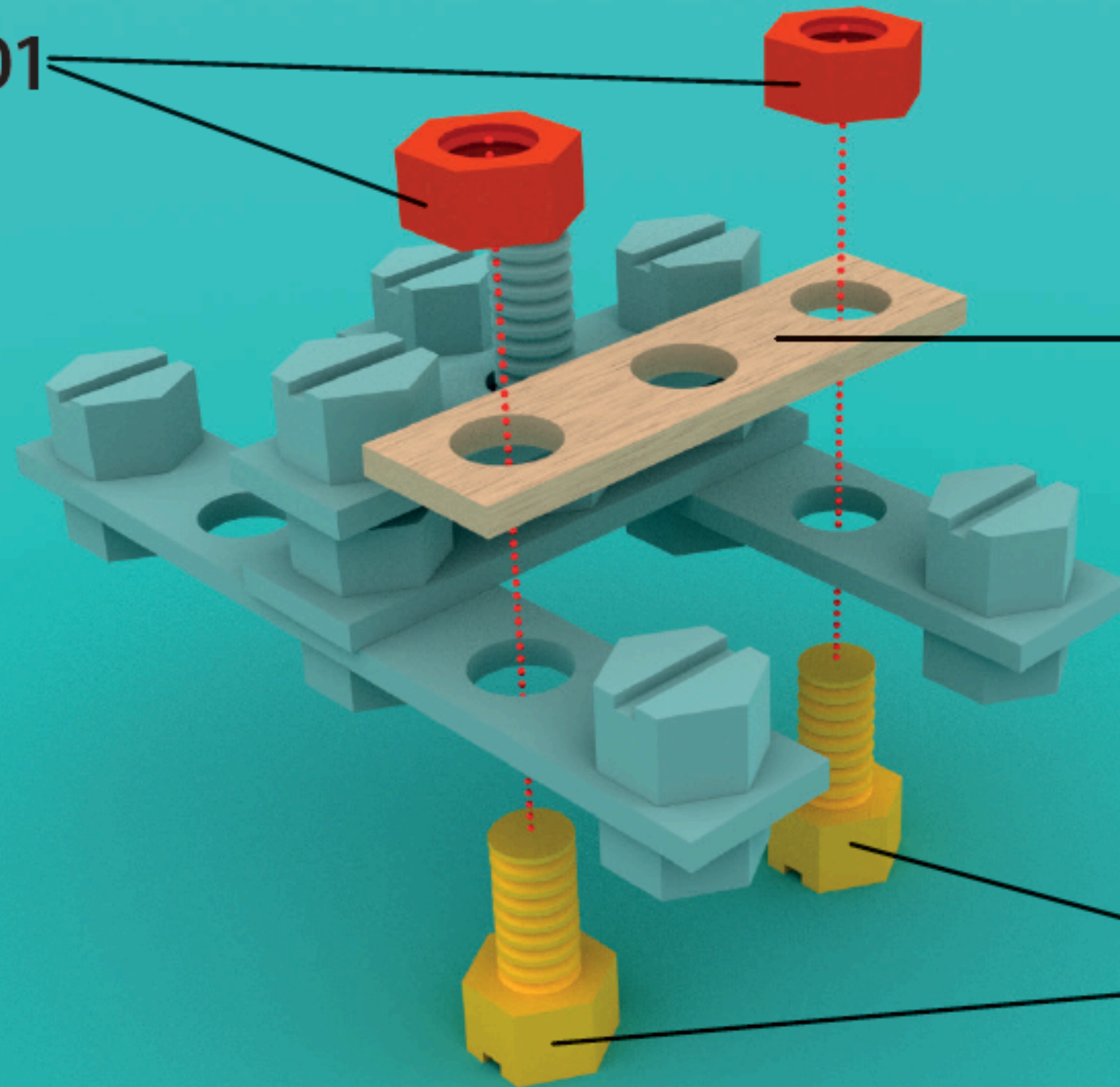

D03

SP004

 x 1

 x 2

 x 2



x 1



x 1

NP001

KP001

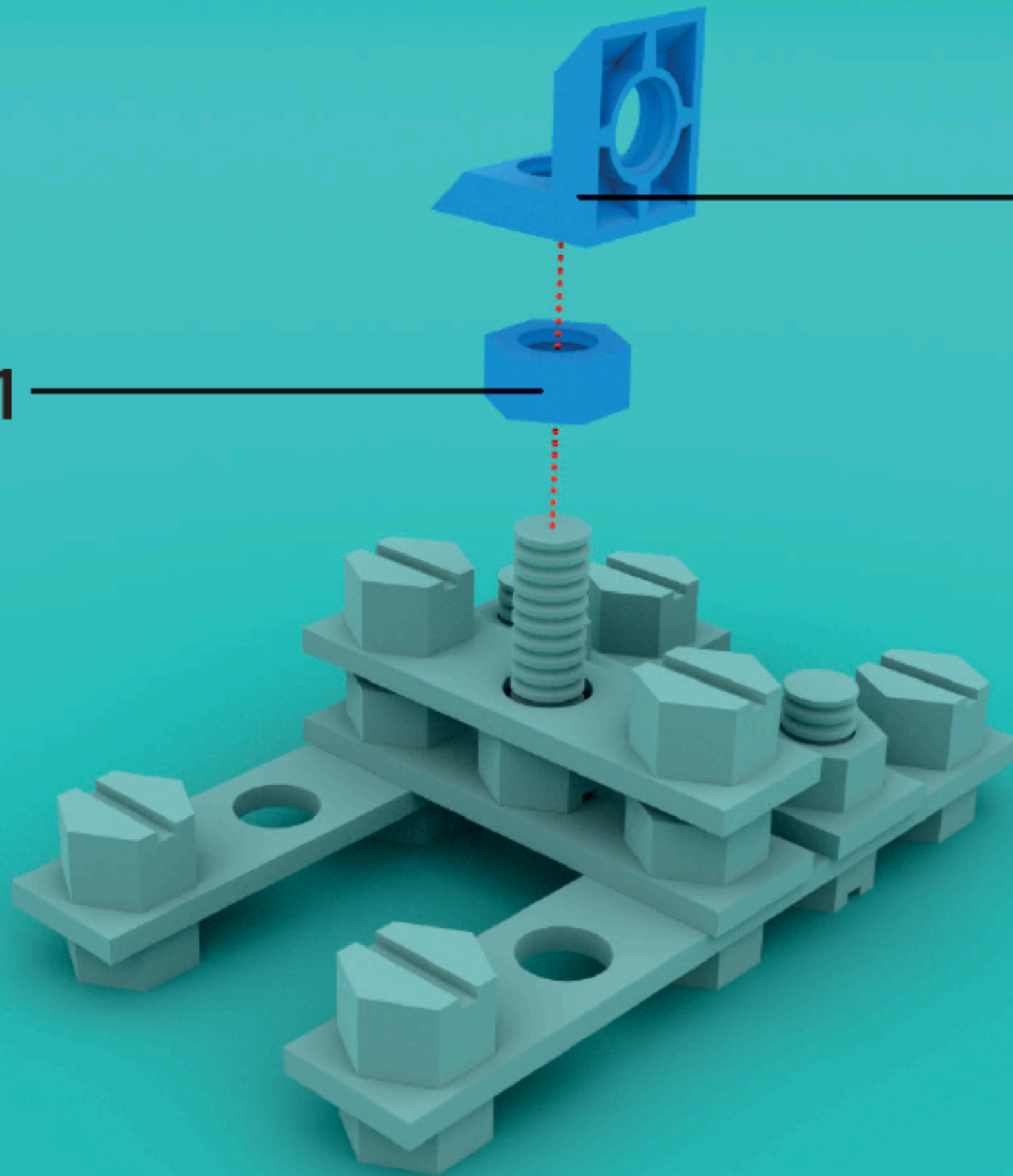



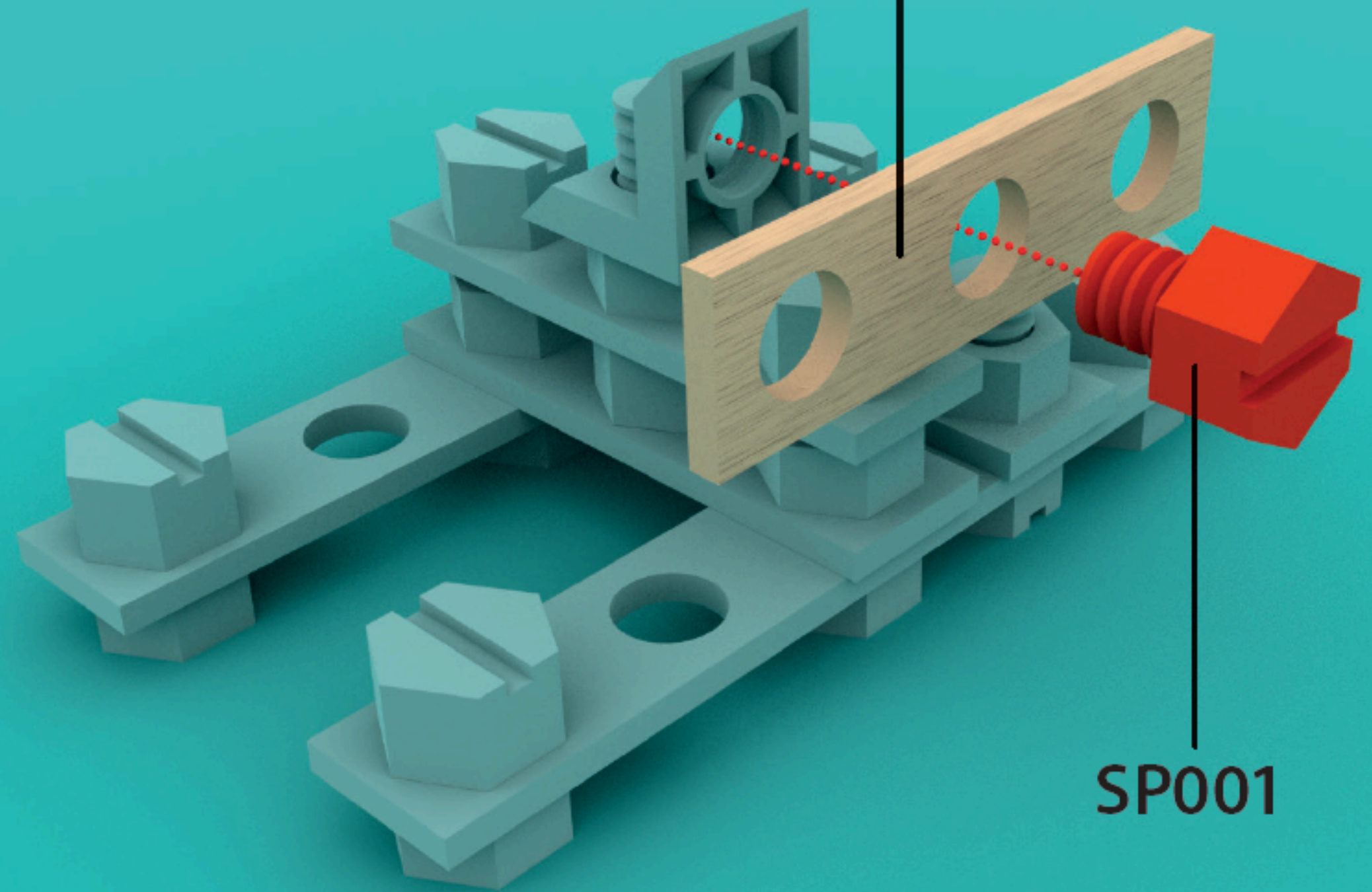

 x 1

 x 1

D03



SP001

-  x 1
-  x 2
-  x 3
-  x 1

NP001

D03

D04

SP003

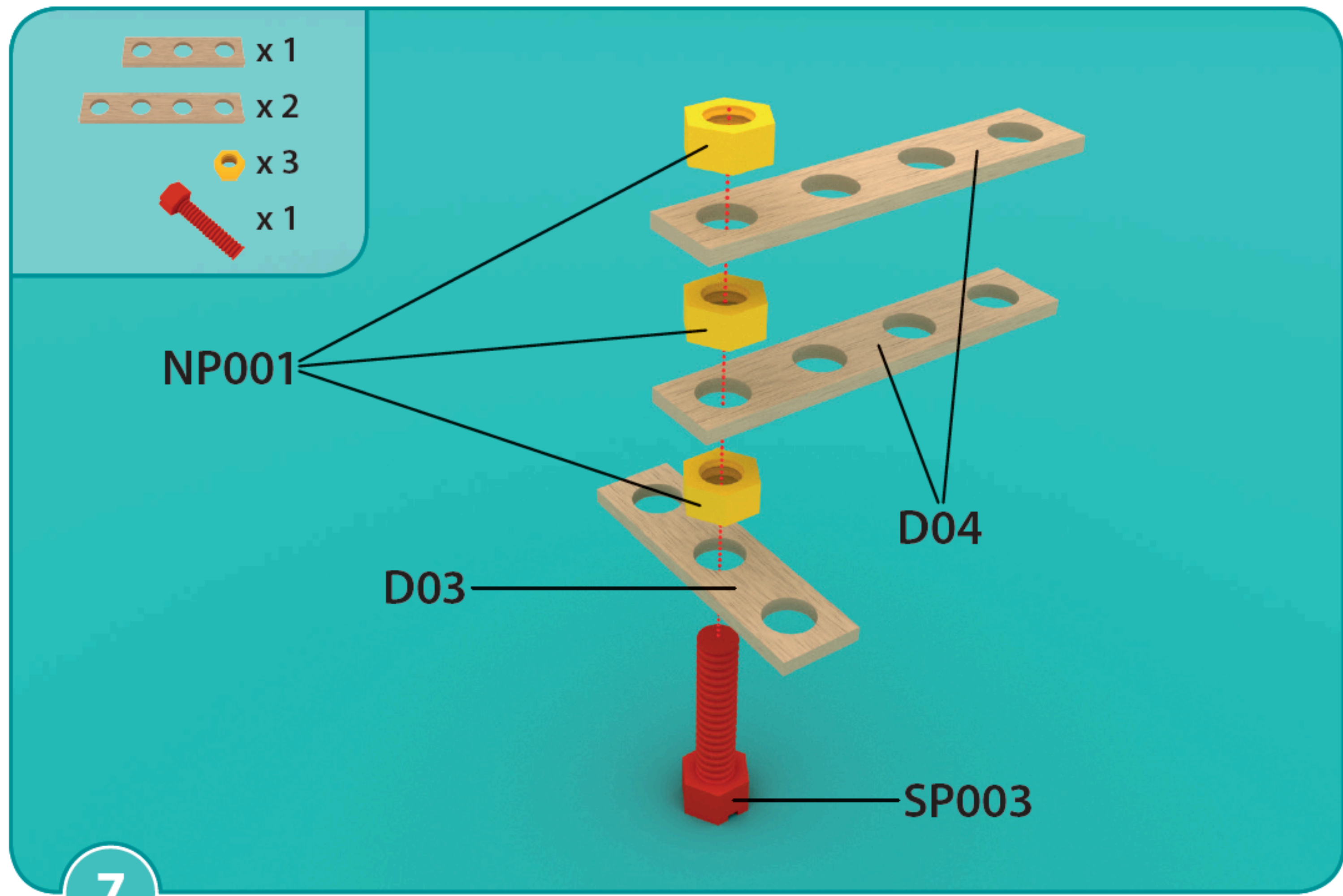

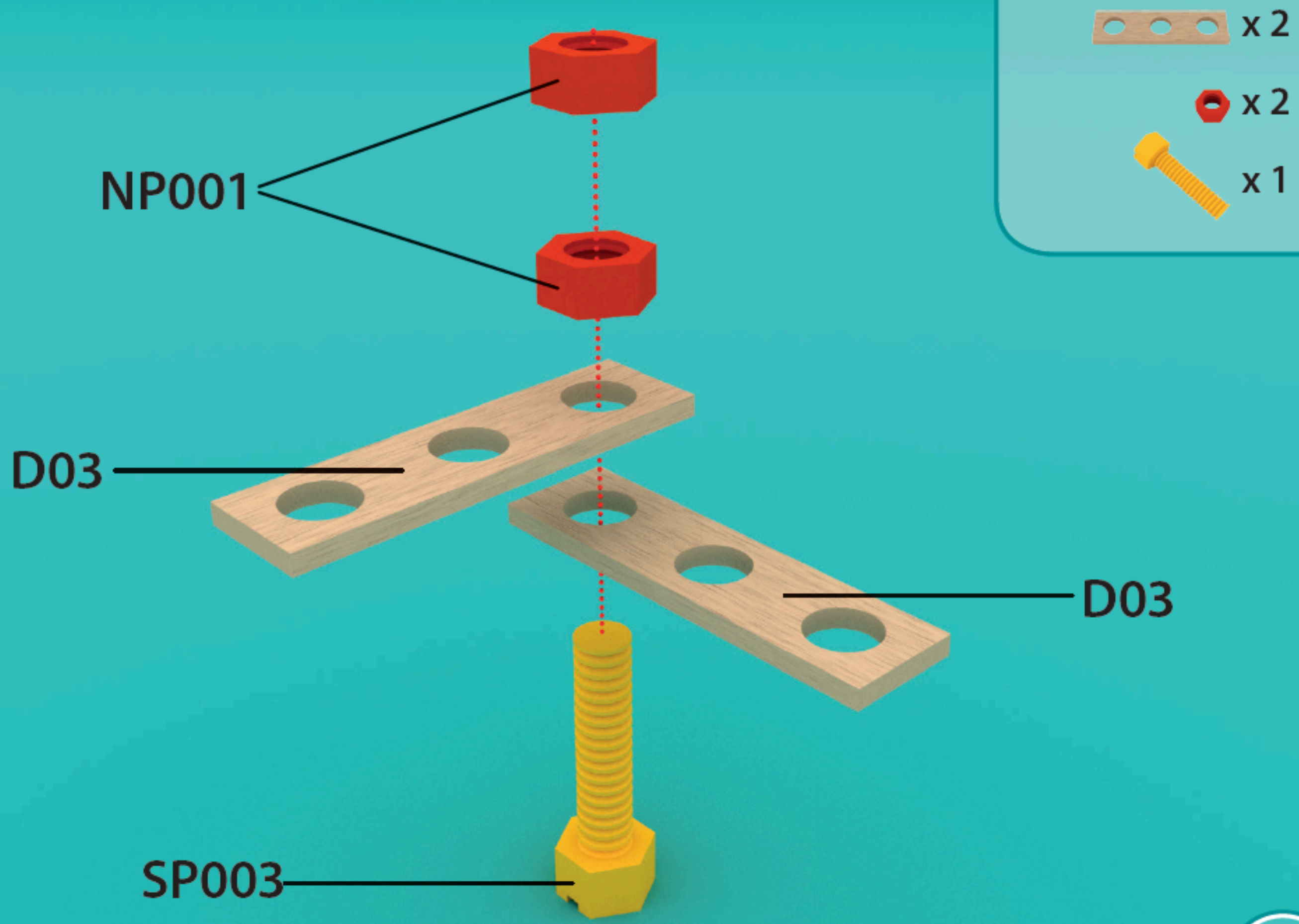

 x 1



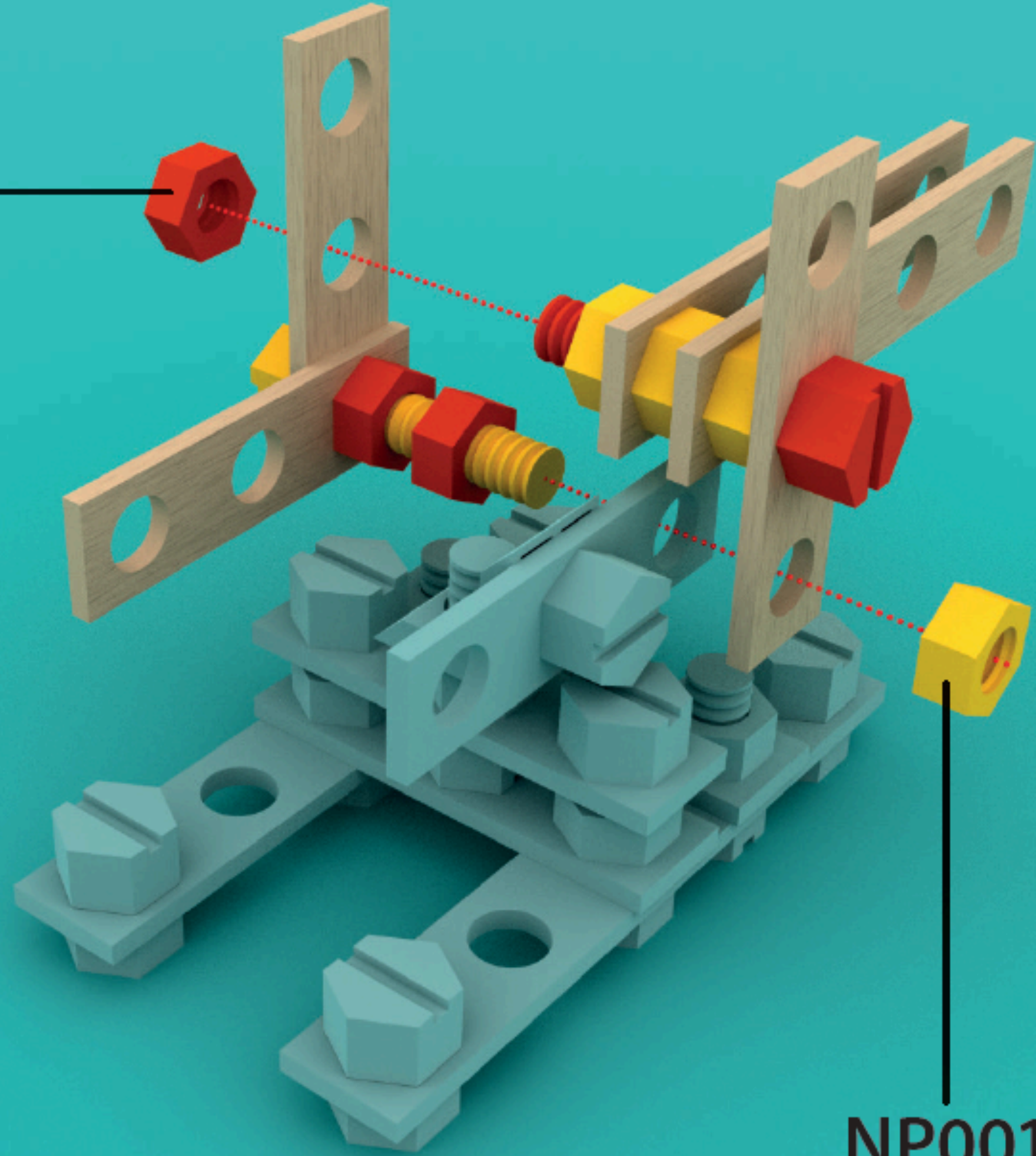

 x 1

NP001

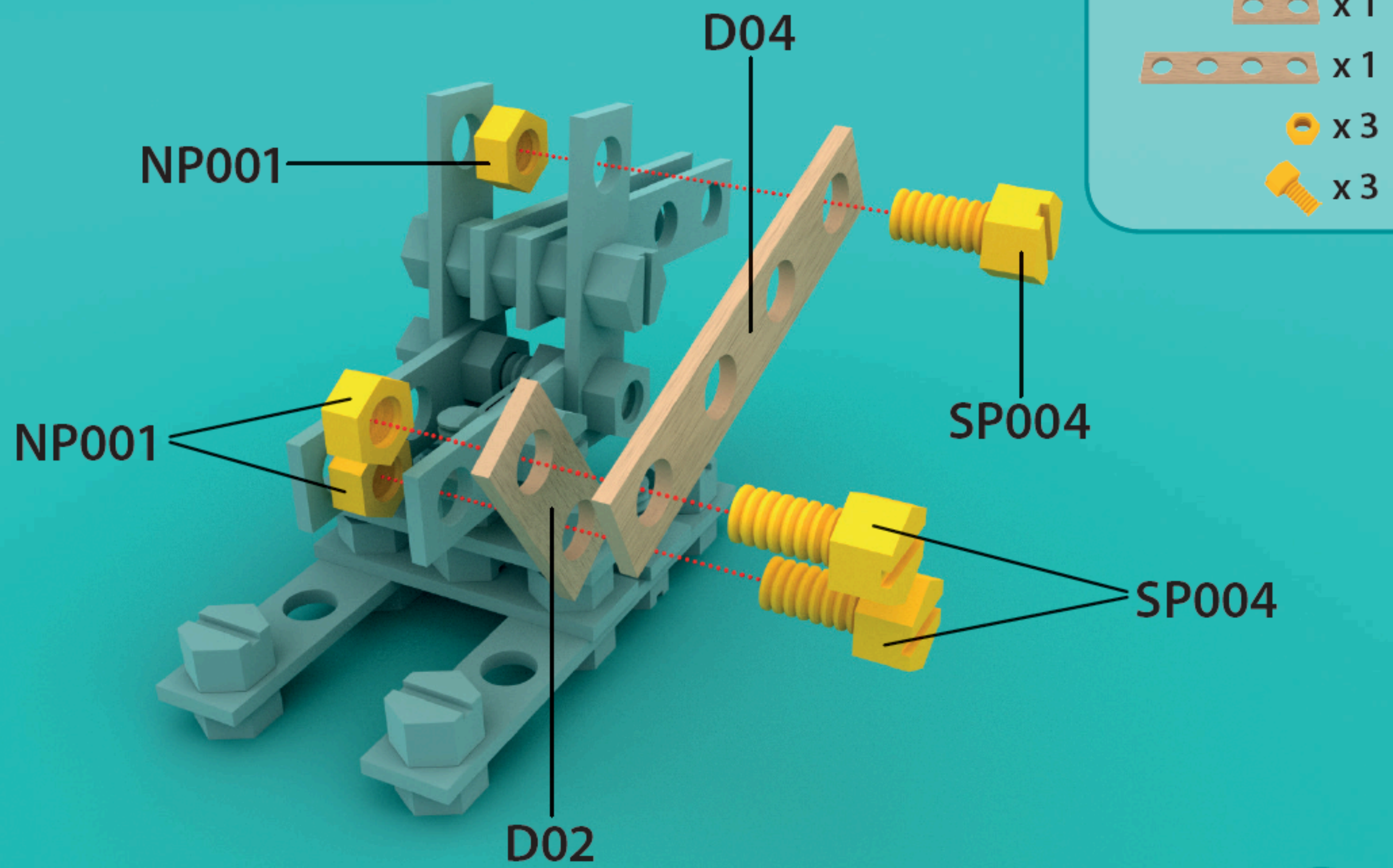

NP001



-  x 1
-  x 1
-  x 1
-  x 2
-  x 3

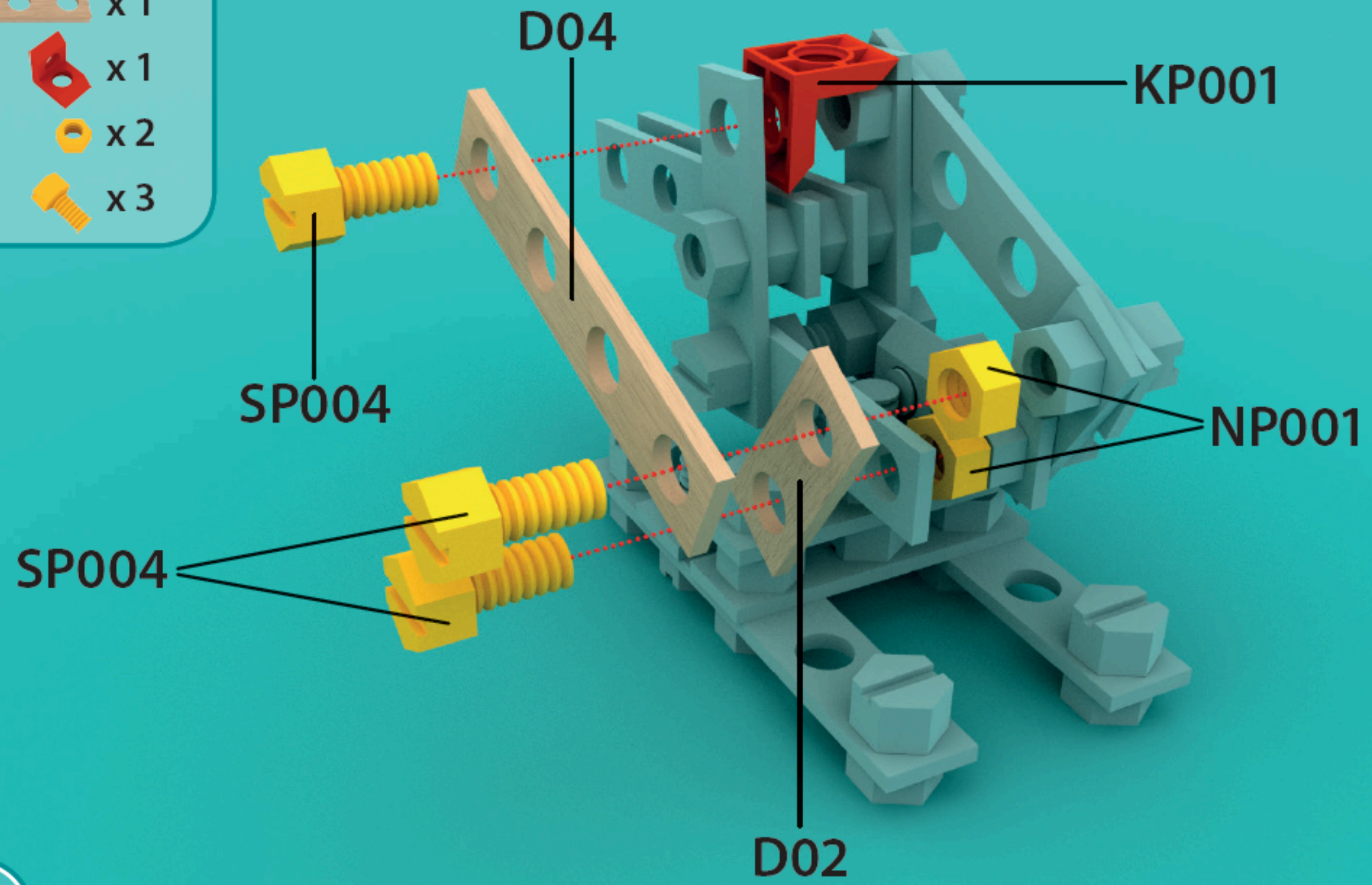

SP003

NP001

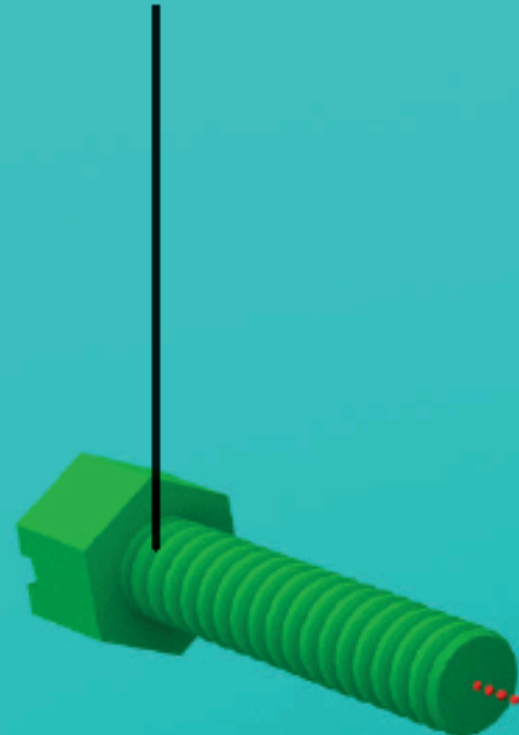

NP001



x 1

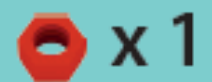

x 1



x 3



x 1

D03

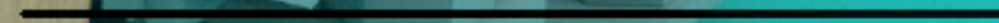

NP001





x 1



x 2



x 1

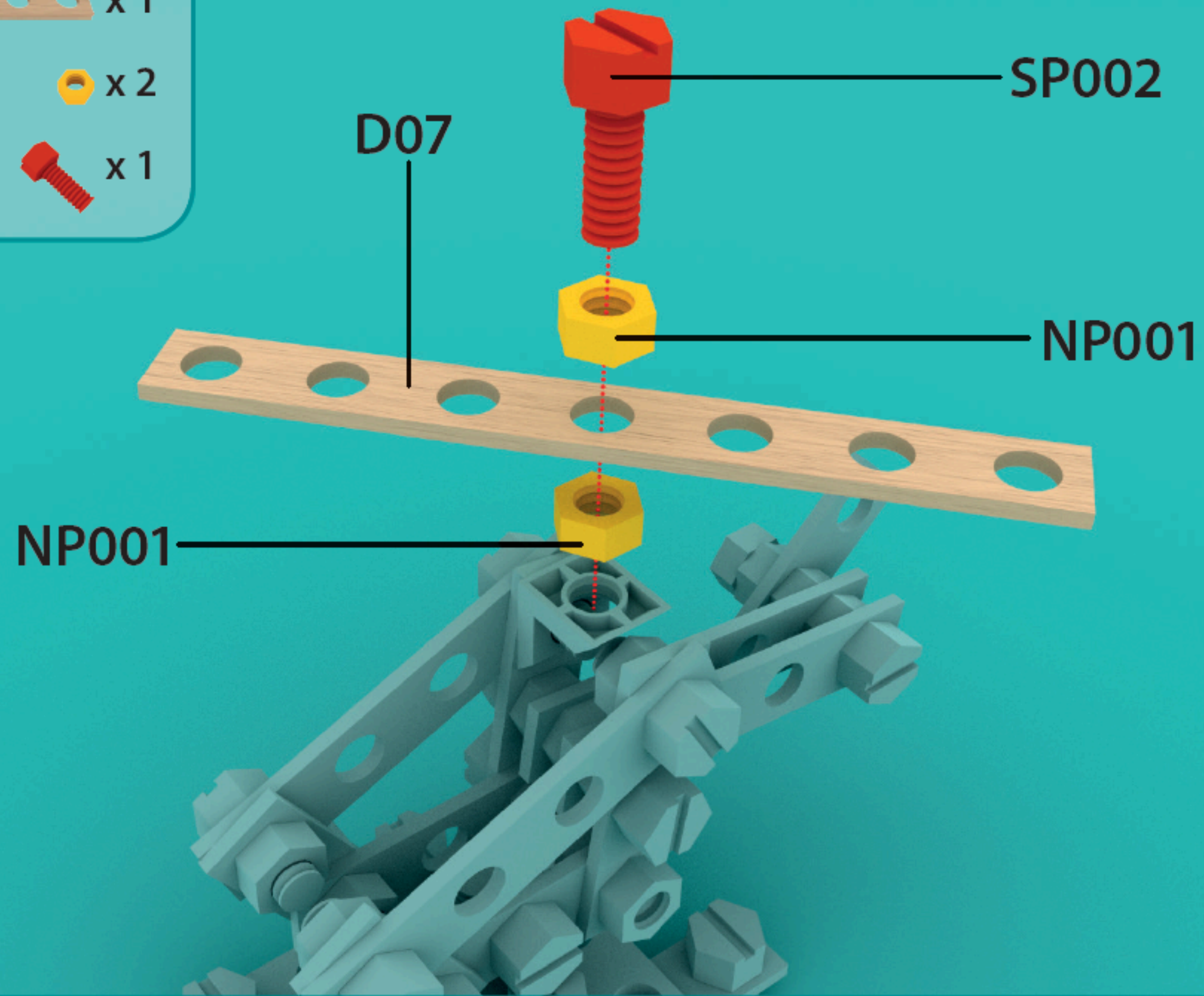

SP002

D07

NP001

NP001





15

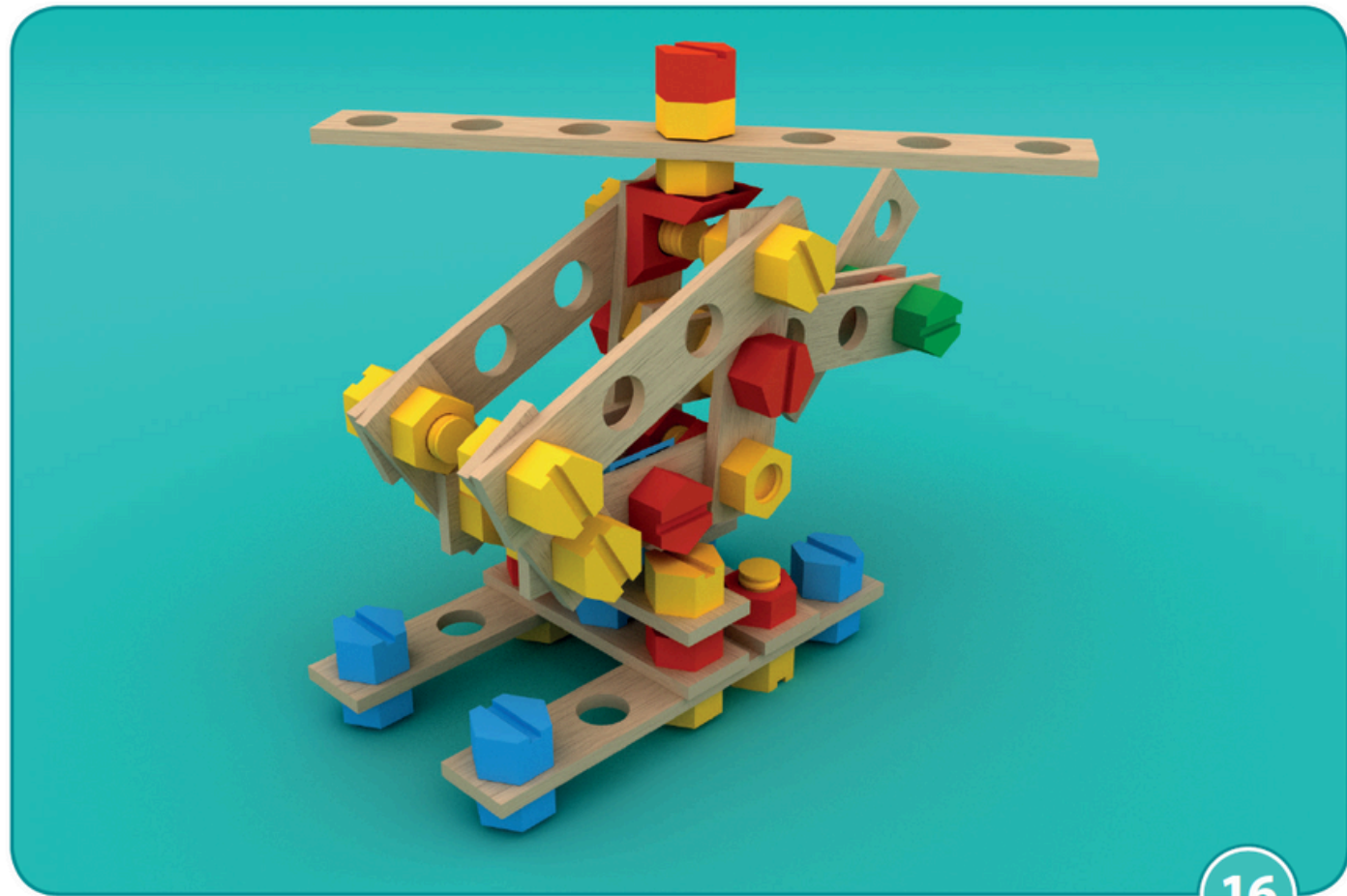

16



17



18

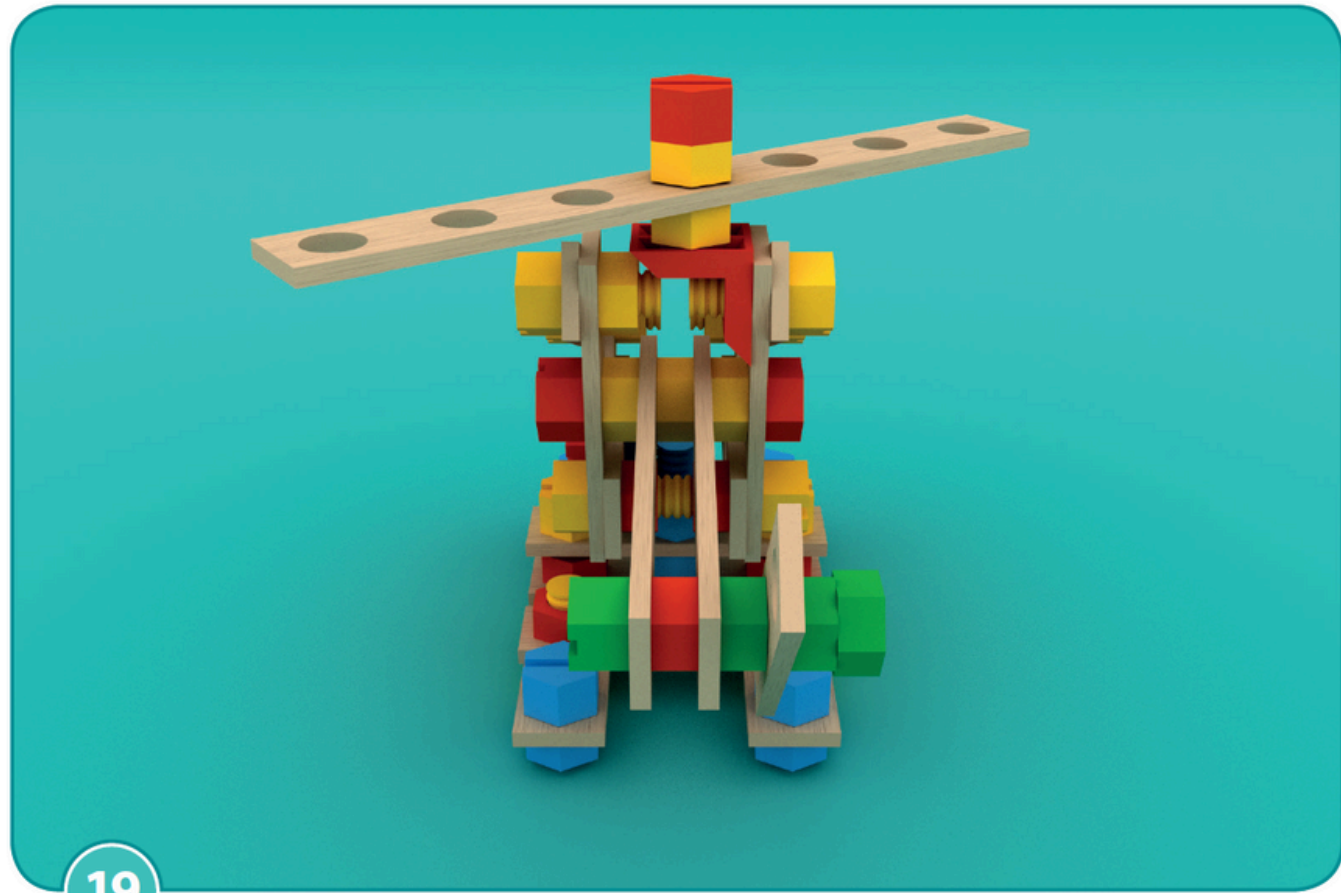

19

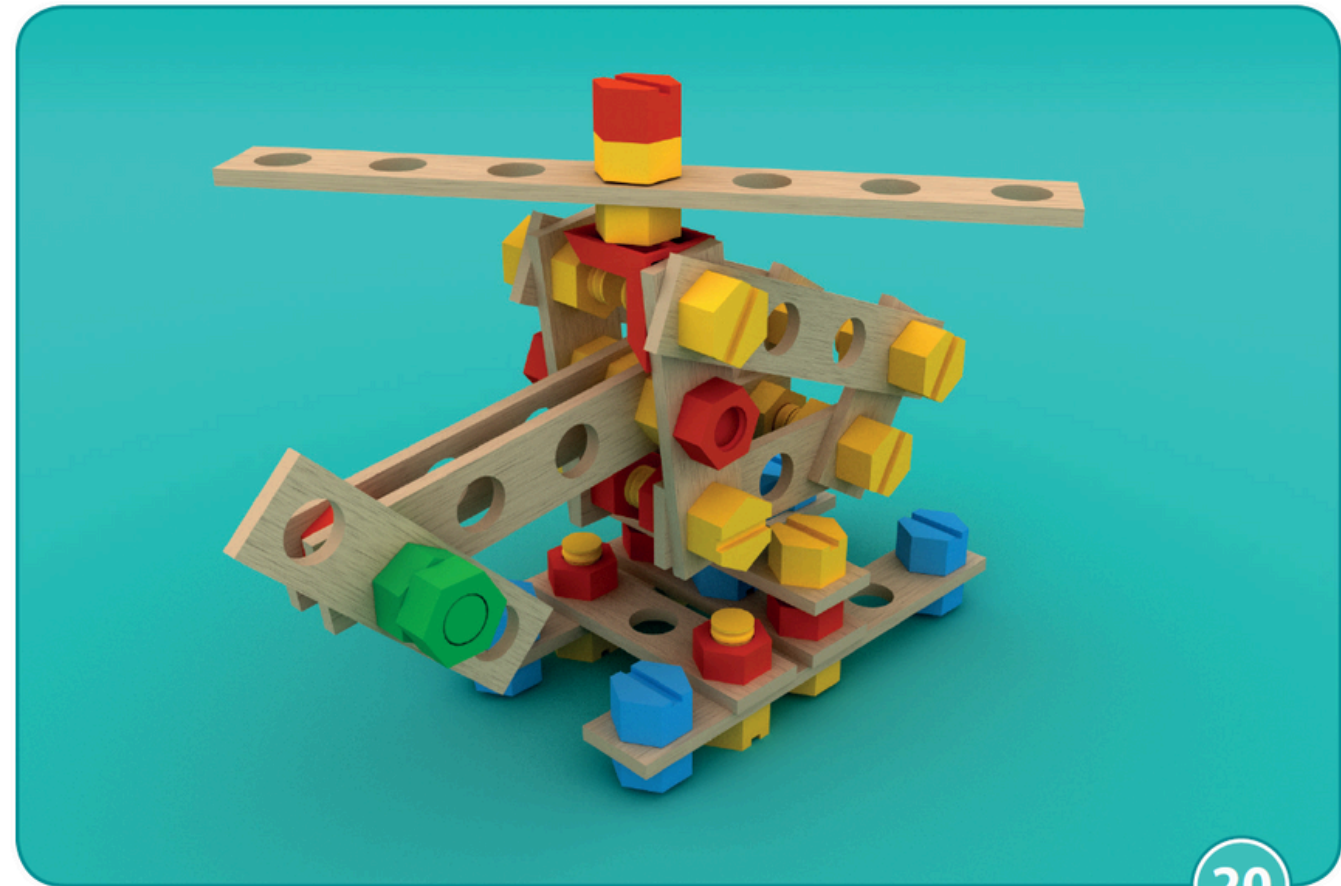

20

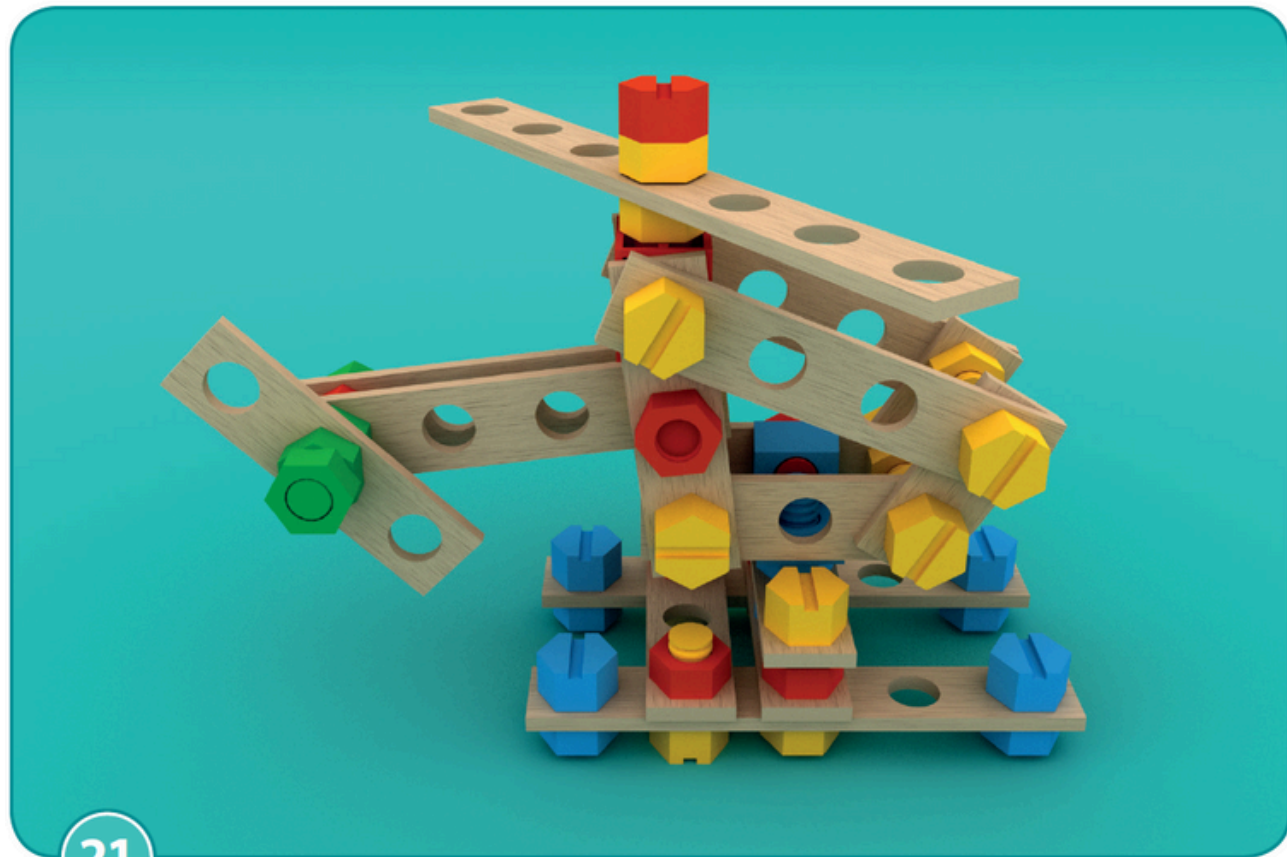

21

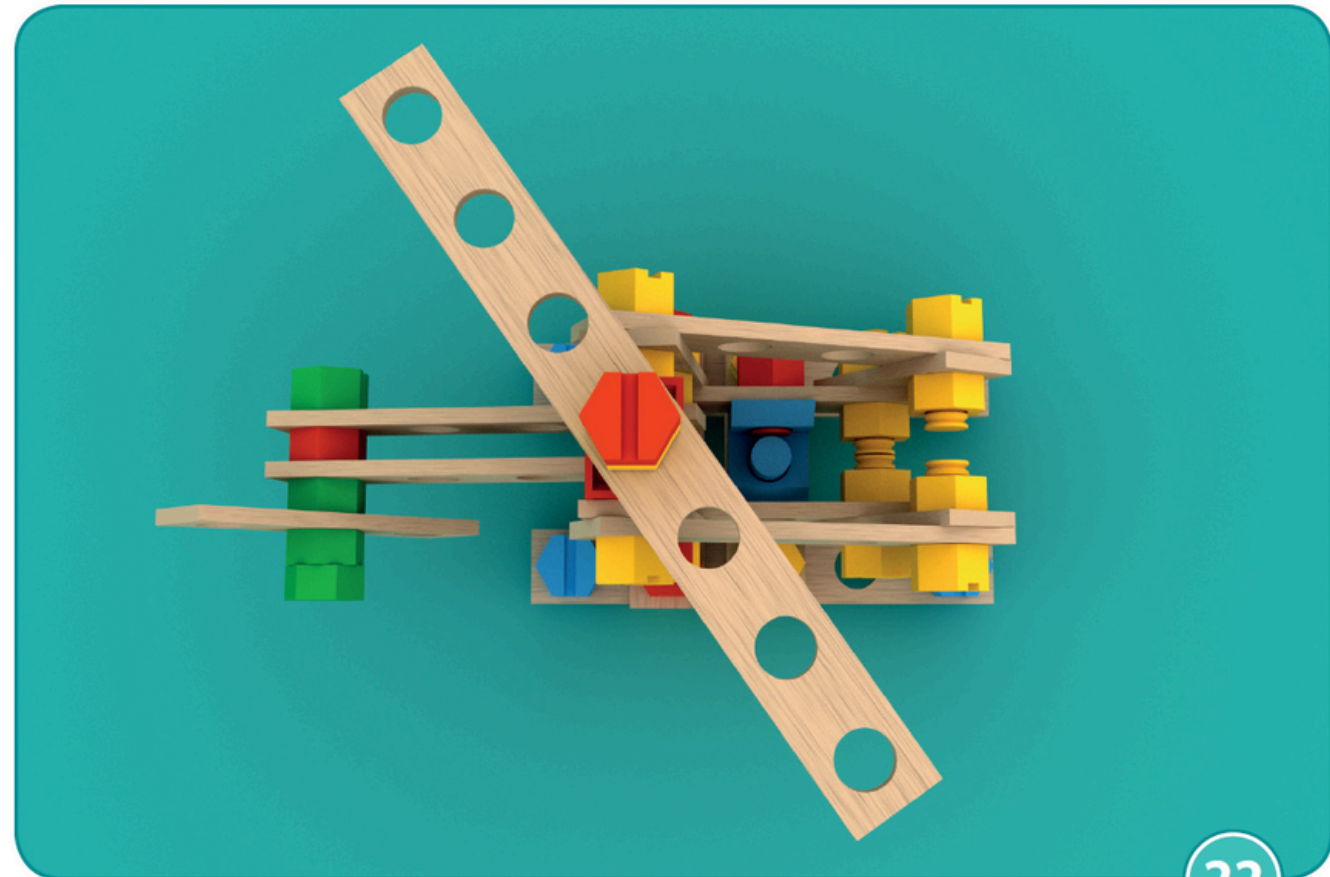

22

PL: Ostrzeżenia! Nieodpowiednie dla dzieci w wieku poniżej 3 lat. Zestaw zawiera małe elementy – niebezpieczeństwo zakrztuszenia. Prosimy zachować opakowanie ze względu na podane informacje. **EN:** Warnings! Unsuitable for children under the age of 3. Contains small parts – choking hazard. Keep the box for future reference. **DE:** Achtung! Nicht für Kinder unter 3 Jahren geeignet. Enthält kleine Teile, die verschluckt werden können – Erstickungsgefahr. Verpackung für spätere Rückfragen aufbewahren. **FR:** Attention! Ne convient pas aux enfants de moins de 3 ans. Contient des petits éléments pouvant être avalés et engendrer un risque d'étouffement. Documentation à lire et à conserver pour consultation ultérieure. **ES:** ¡Advertencia! No recomendable para niños de 3 años o menores. Peligro de asfixia – piezas pequeñas. Conserve la caja para futuras referencias. **NL:** Waarschuwing! Niet geschikt voor kinderen jonger dan drie jaar. Bevat kleine onderdelen – verstikkingsgevaar opleveren. Bewaar de verpakking, er staat belangrijke informatie op. **CZ:** Upozornění! Nevhodné pro děti do 3 let. Balení obsahuje malé dílky – nebezpečí udušení. Zachovejte prosím obal ze vzhledu na uvedené informace. **SK:** Upozornenia! Nevhodné pre deti vo veku do 3 rokov. Súprava obsahuje malé casti – hrozí nebezpečenstvo udusenía. Obal uschovajte vzhľadom na dôležité informácie, ktoré sa na nom nachádzajú.



www.alexander.com.pl